

REV #	DATE	DRAWN BY
1	1/19/2021	LJ

30"D x 48"W - Electric - Casters

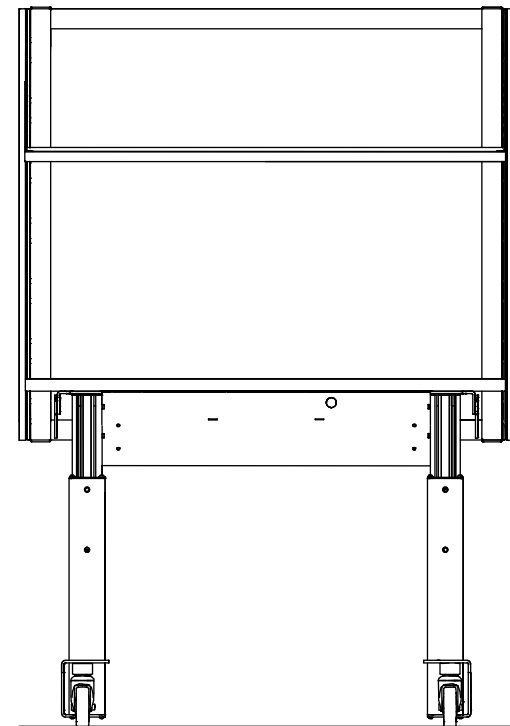

Elevation A

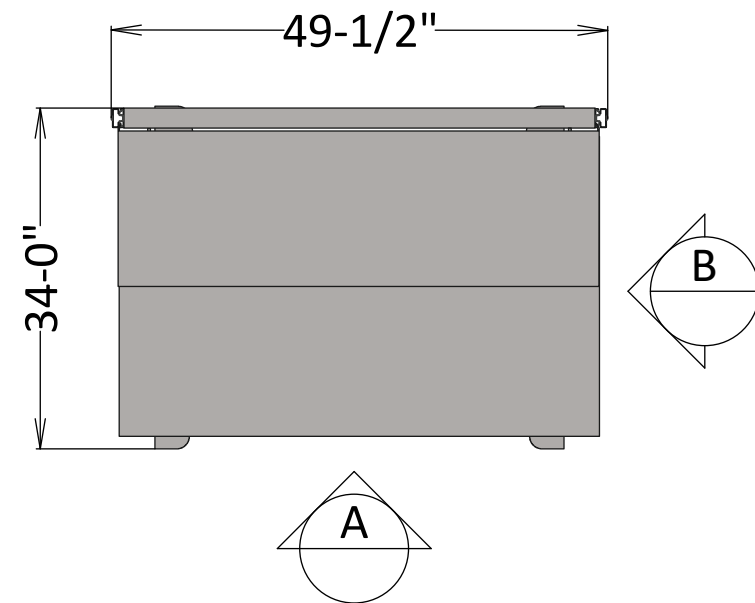
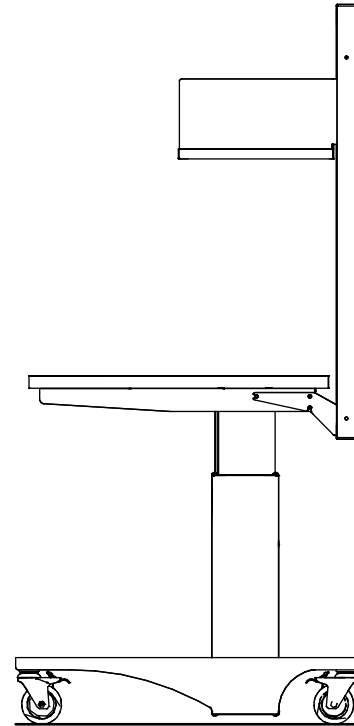

Elevation B

